

UNDERSHELF ASSEMBLY DETAILS BENCH NOT INCLUDED

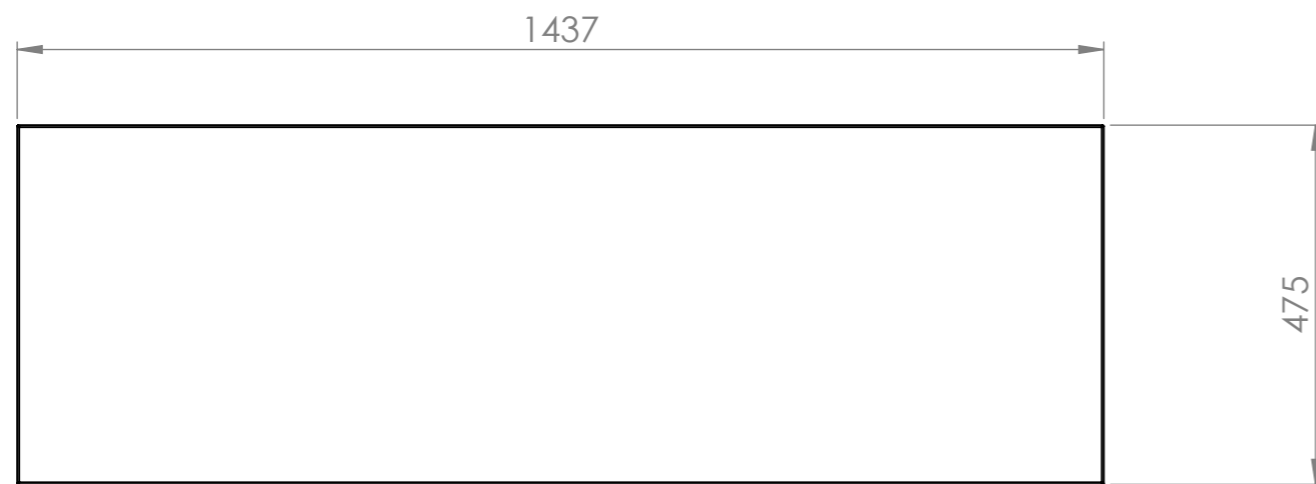

PLAN

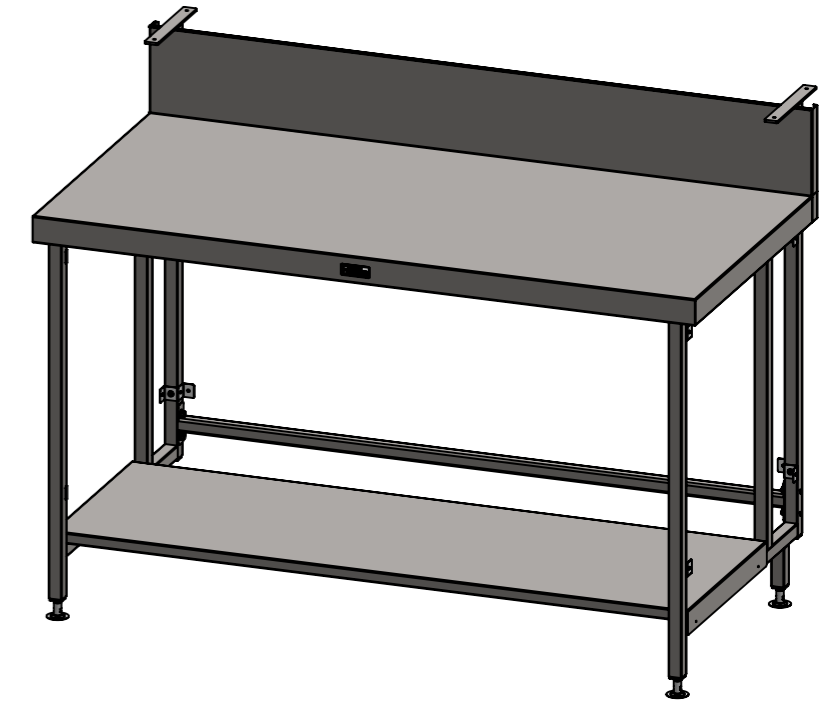
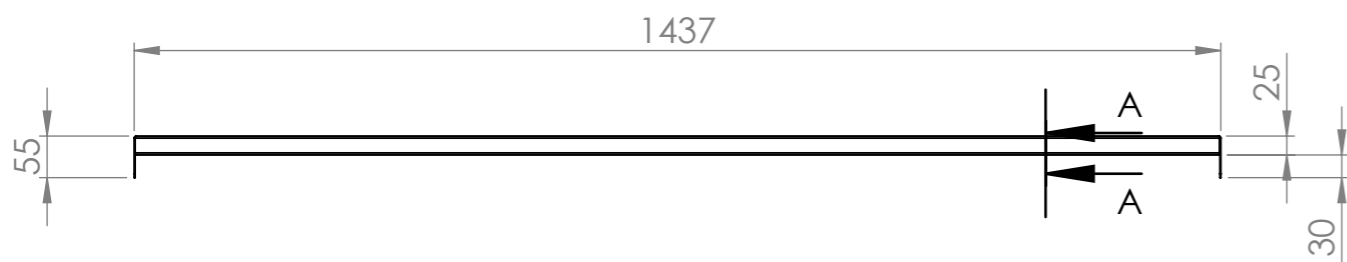

FRONT ELEVATION

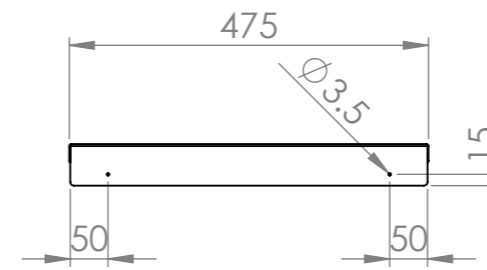

SIDE ELEVATION

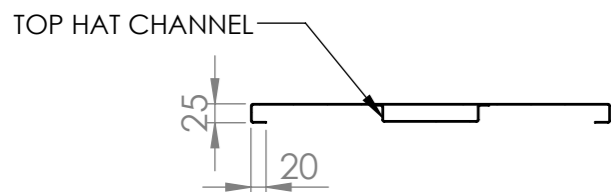

SECTION A-A

**SBM-US-7-1500**



Modular Bar Solutions

COPYRIGHT © 2022

This drawing is the property of CI GROUP PTY LTD. Tradings as SIMPLY BARS and It may not be copied, reproduced or modified in whole or in part without prior written permission of CI GROUP PTY LTD. SIMPLY BARS reserves the right to change specification and design without notice.

**SBM-US-7-1500**  
**BAR MODULE UNDERSHELF**

SIZE: A3

SCALE : 1:10

CONSTRUCTION NOTES :

1. UNDERSHELF MADE FROM 1.2mm STAINLESS STEEL.