

FRONT ELEVATION

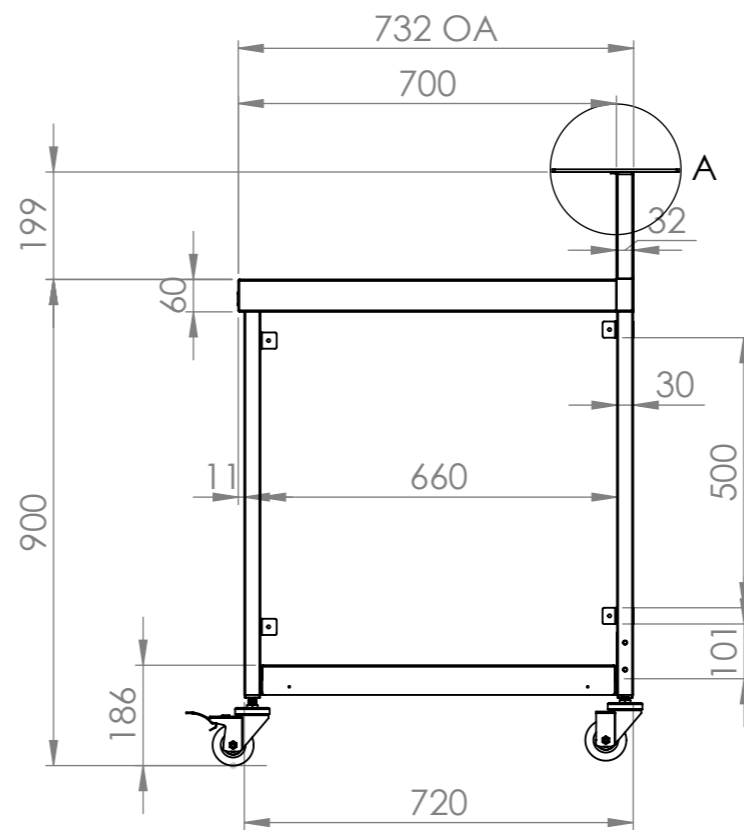

SIDE ELEVATION

SBM-M-7-1500



Modular Bar Solutions

COPYRIGHT © 2022

This drawing is the property of CI GROUP PTY LTD. Tradings as SIMPLY BARS and It may not be copied, reproduced or modified in whole or in part without prior written permission of CI GROUP PTY LTD. SIMPLY BARS reserves the right to change specification and design without notice.

SBM-M-7-1500
MOBILE BAR MODULE, 1500mm

SIZE: A3

SCALE: 1:14

CONSTRUCTION NOTES :

1. TOPS MADE FROM 304 GRADE, 1.2mm STAINLESS STEEL.
2. LEG FRAME MADE FROM 30mm STAINLESS STEEL SQ TUBE.
3. FEET ARE Ø75MM STAINLESS STEEL HEAVY DUTY CASTORS. 2X LOCKING & 2X NON-LOCKING.
4. UNDERSHELF MADE FROM 1.2mm STAINLESS STEEL.