

PLAN

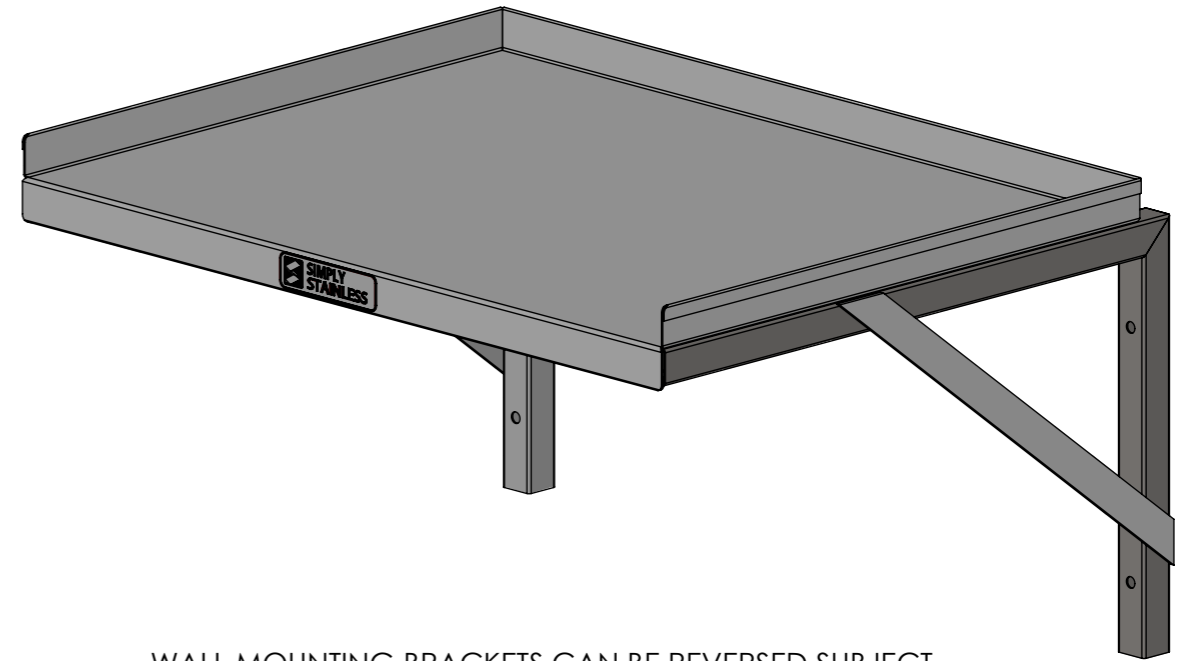

WALL MOUNTING BRACKETS CAN BE REVERSED SUBJECT TO SITE REQUIREMENTS.

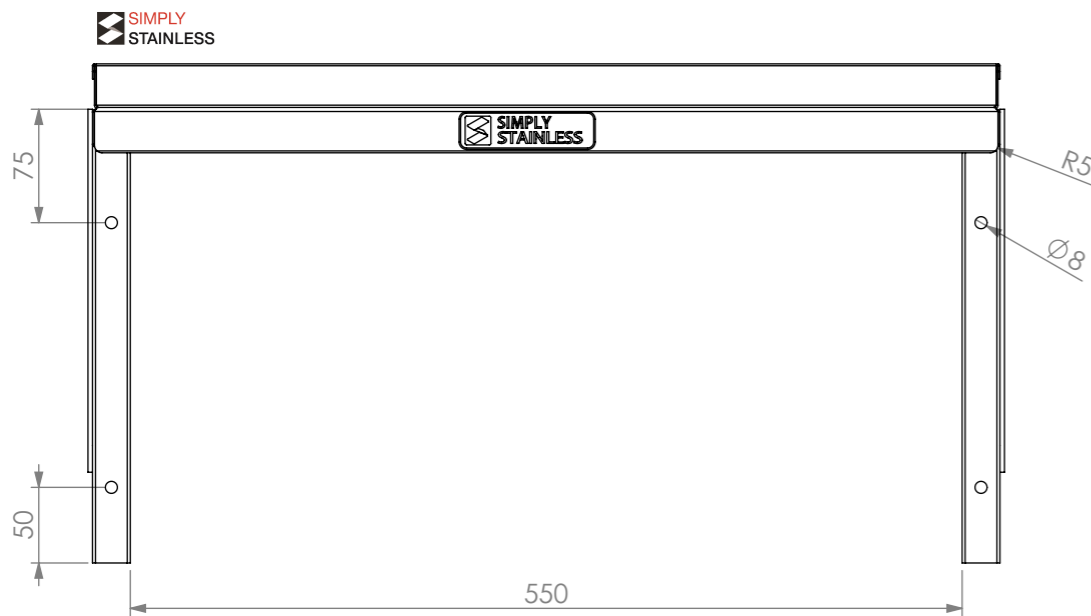

FRONT ELEVATION

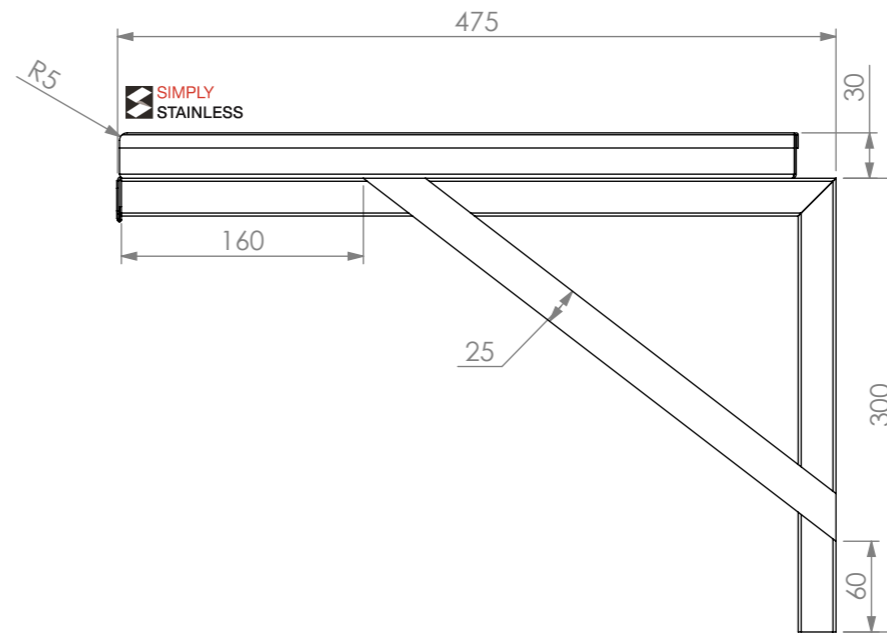

SIDE ELEVATION

**28-MV-0450**

**SIMPLY STAINLESS**  
 Modular Sinks, Tables & Shelving  
 COPYRIGHT © 2022  
 This drawing is the property of CI GROUP PTY LTD. Tradings as SIMPLY STAINLESS and it may not be copied, reproduced or modified in whole or in part without prior written permission of CI GROUP PTY LTD. SIMPLY STAINLESS reserves the right to change specification and design without notice.

**28-MV-0450**  
**MICROWAVE SHELF**

SIZE: A3

SCALE : 1:5

**CONSTRUCTION NOTES :**

1. TOPS MADE FROM 1.2mm STAINLESS STEEL.
2. TUBE MADE FROM 25x25x1.2mm STAINLESS STEEL.
3. FLAT BAR MADE FROM 25x3 STAINLESS STEEL.