

PLAN

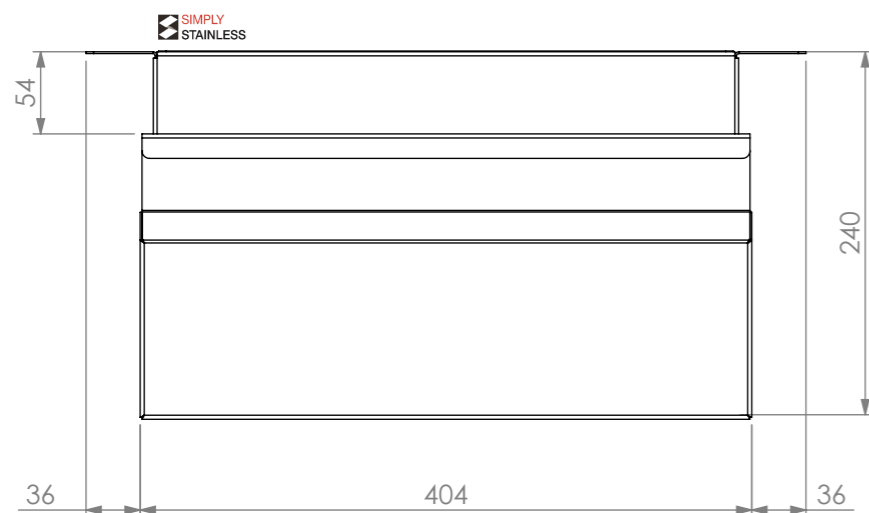

FRONT ELEVATION

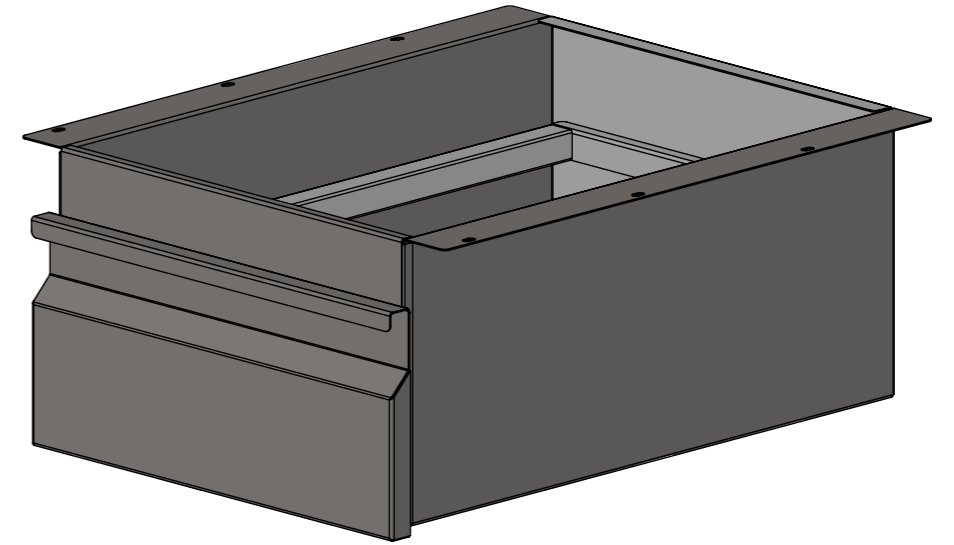
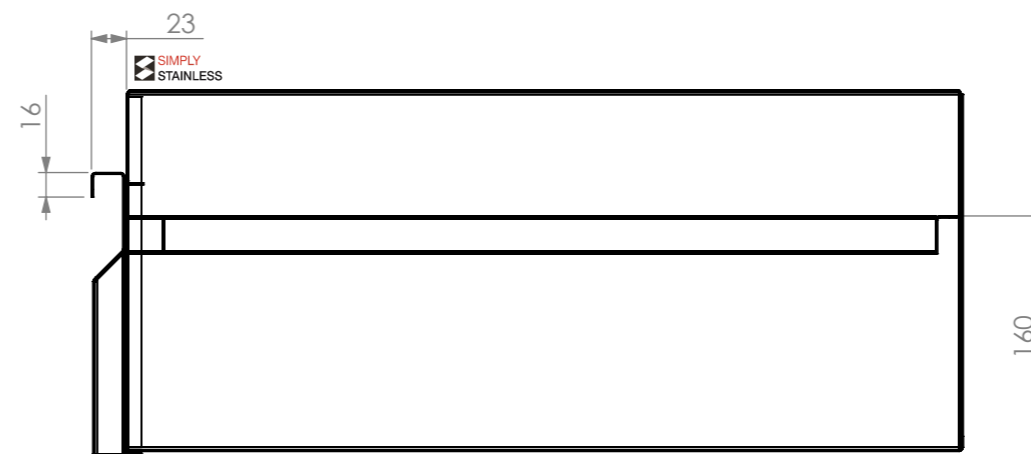

SIDE ELEVATION

SIMPLY STAINLESS
 Modular Sinks, Tables & Shelving
 COPYRIGHT © 2022
 This drawing is the property of CI GROUP PTY LTD. Tradings as SIMPLY STAINLESS and it may not be copied, reproduced or modified in whole or in part without prior written permission of CI GROUP PTY LTD. SIMPLY STAINLESS reserves the right to change specification and design without notice.

**19-GN
 DRAWER**

SIZE: A3

SCALE : 1:5

CONSTRUCTION NOTES :

1. DRAWERS MADE FROM 1mm STAINLESS STEEL.
2. FRAME MADE FROM 25mm STAINLESS STEEL SQ. TUBE.

19-GN