

PLAN

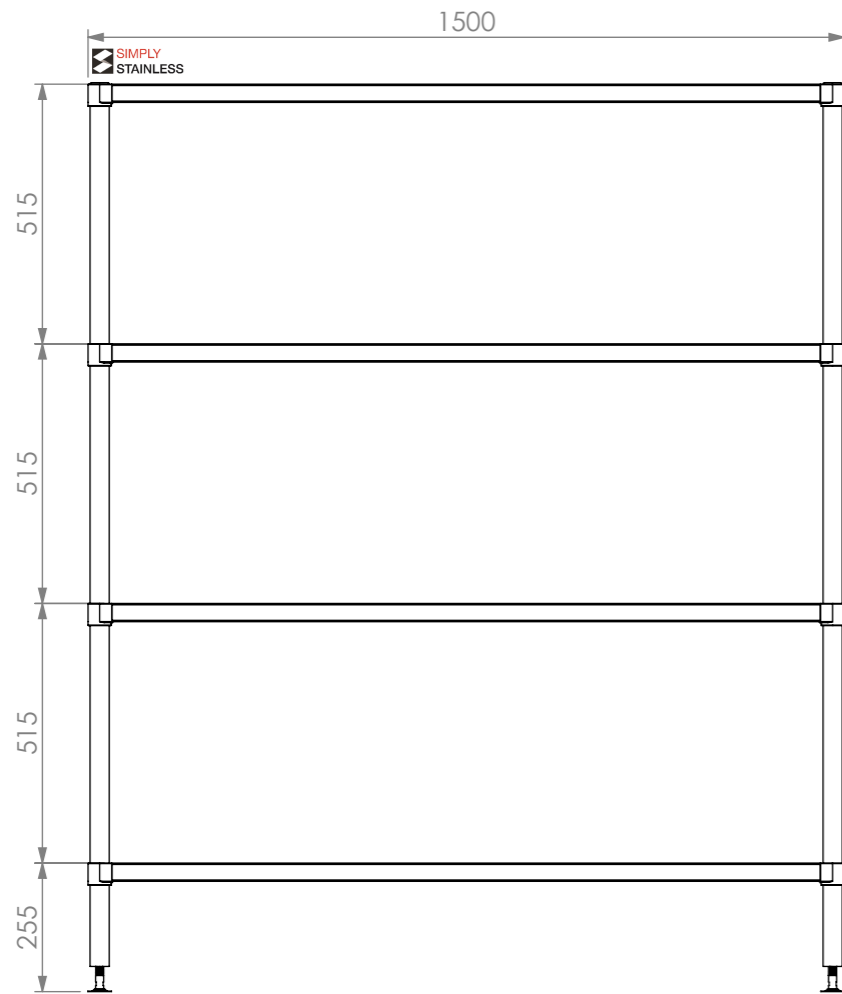

FRONT VIEW

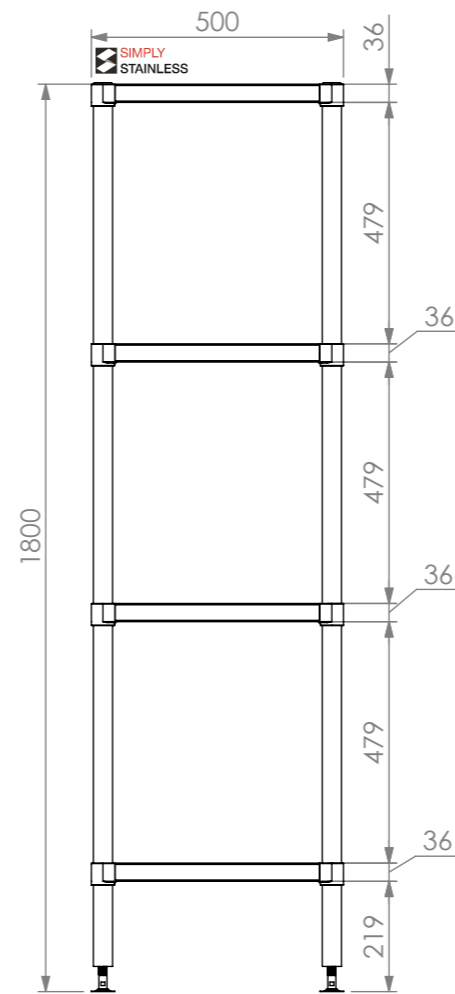

SIDE VIEW

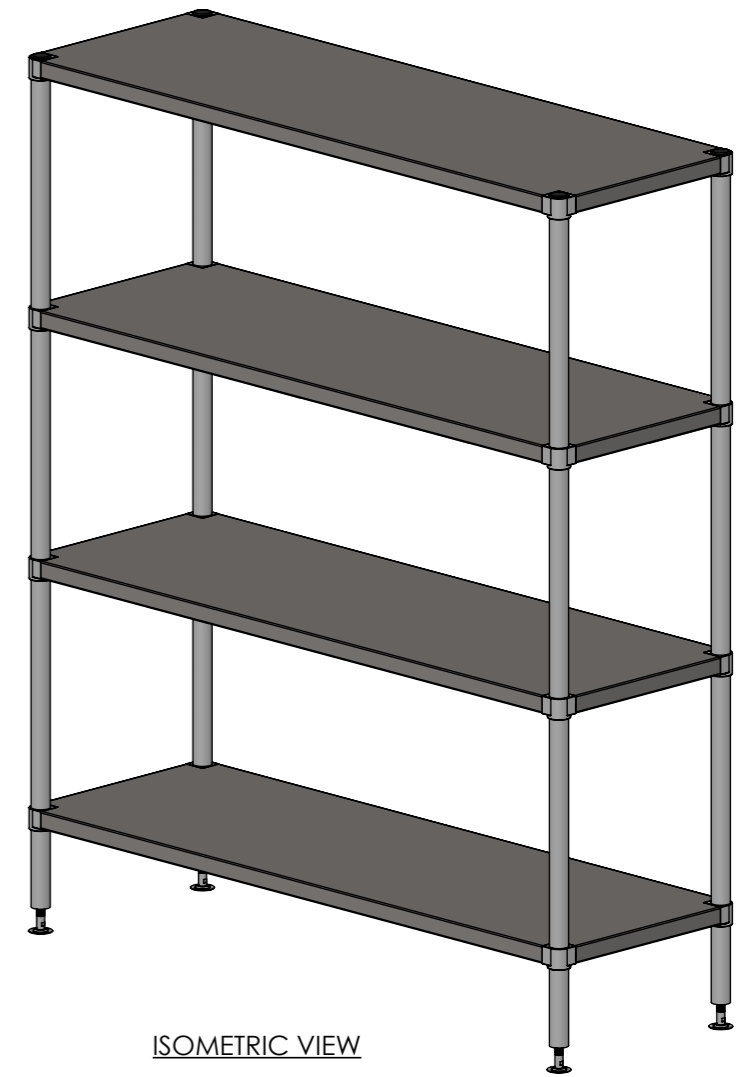

ISOMETRIC VIEW



Modular Sinks, Tables & Shelving

COPYRIGHT © 2022

This drawing is the property of CI GROUP PTY LTD. Tradings as SIMPLY STAINLESS and it may not be copied, reproduced or modified in whole or in part without prior written permission of CI GROUP PTY LTD. SIMPLY STAINLESS reserves the right to change specification and design without notice.

**17-1500SS  
ADJUSTABLE 4 TIER STORAGE SHELF**

SIZE: A3

SCALE : 1:15

**CONSTRUCTION NOTES :**

1. TOPS MADE FROM 1.2mm STAINLESS STEEL.
2. TUBE MADE FROM Ø38mm STAINLESS STEEL TUBE.
3. FEET ARE ADJUSTABLE STAINLESS STEEL DISC FEET.

**17-1500 SS**