

PLAN

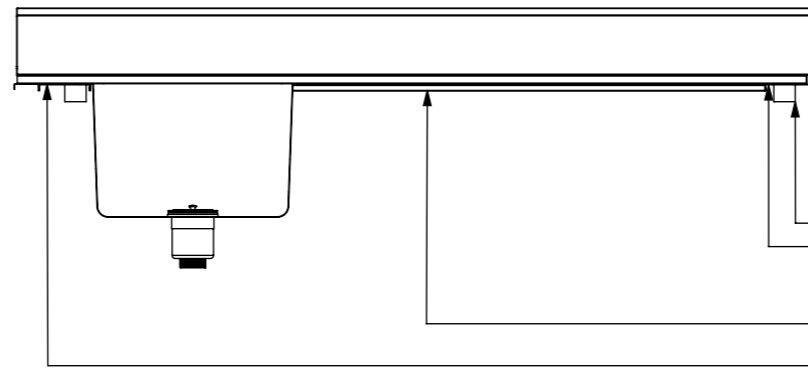

SECTION K-K

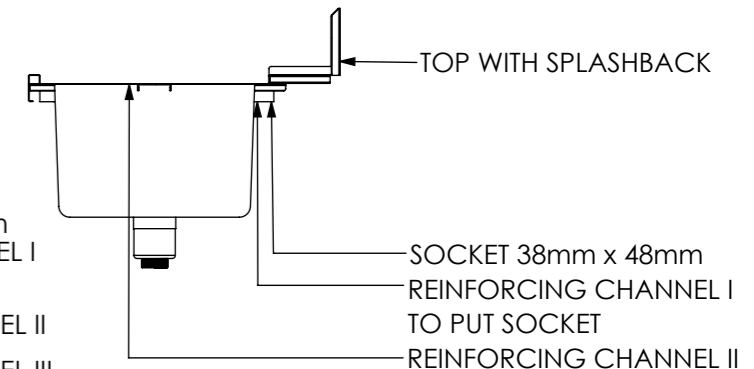

SECTION J-J

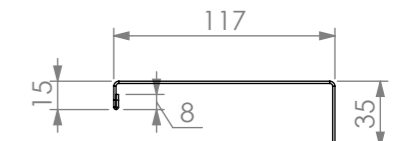
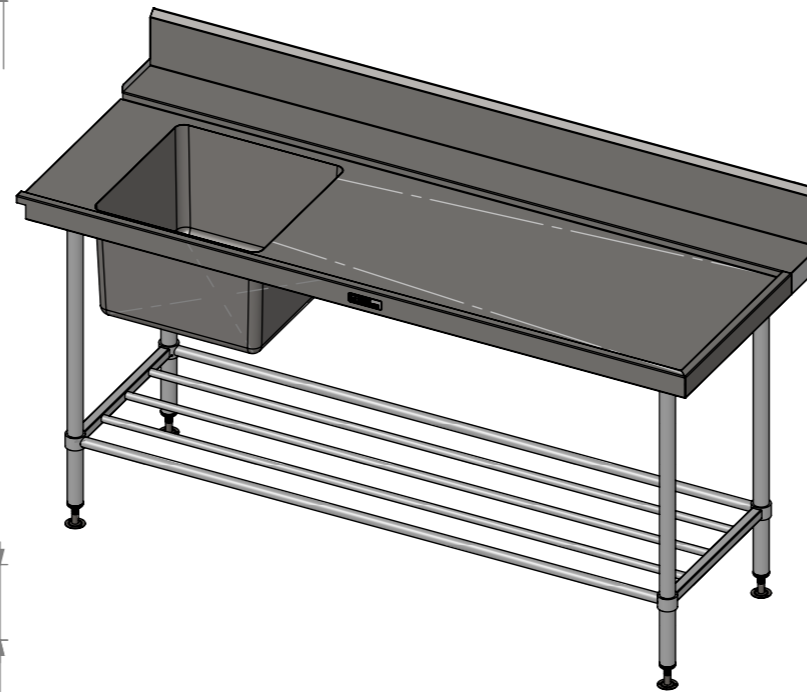

REINFORCING CHANNEL I
DETAIL

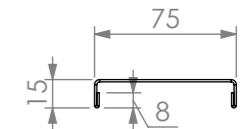

REINFORCING CHANNEL II
DETAIL

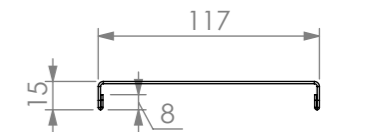

REINFORCING CHANNEL III
DETAIL

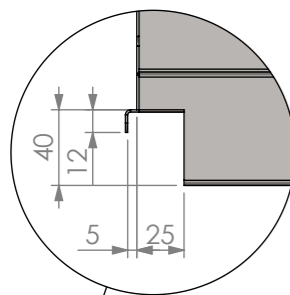

NOTCH DETAIL

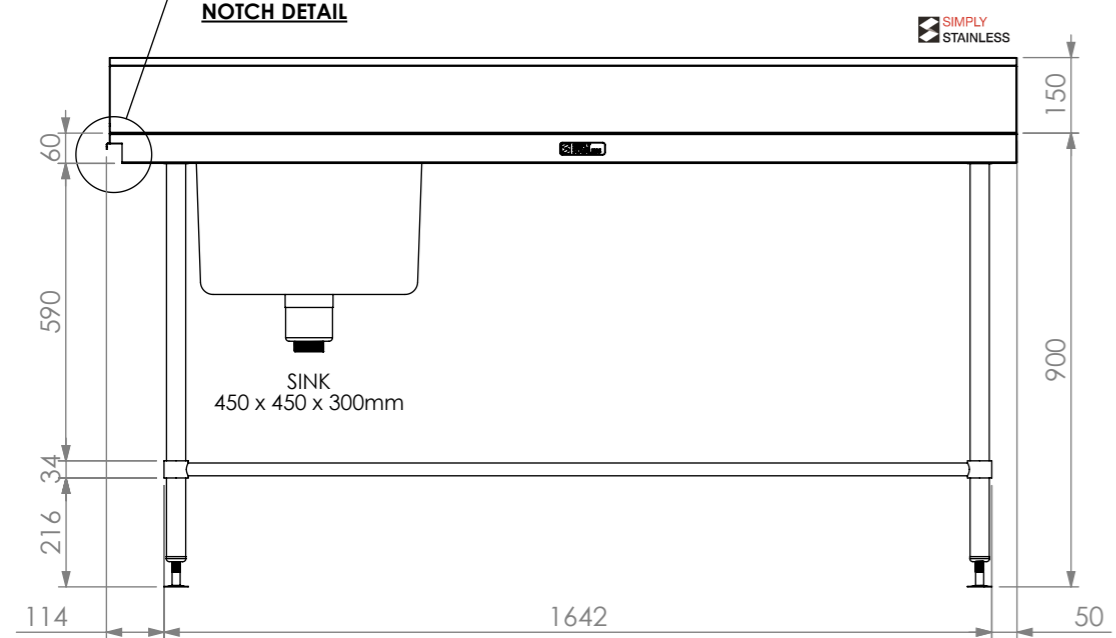

FRONT ELEVATION

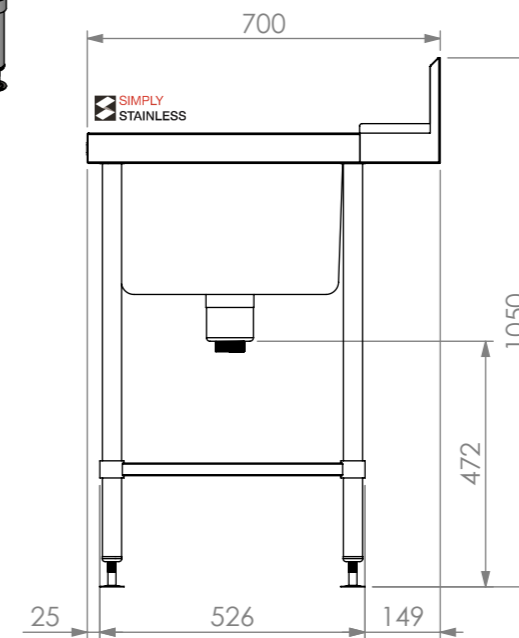

SIDE ELEVATION

SIMPLY STAINLESS
 Modular Sinks, Tables & Shelving
 COPYRIGHT © 2022
 This drawing is the property of CI GROUP PTY LTD. Tradings as SIMPLY STAINLESS and it may not be copied, reproduced or modified in whole or in part without prior written permission of CI GROUP PTY LTD. SIMPLY STAINLESS reserves the right to change specification and design without notice.

08-7-1800R
DISHWASH INLET BENCH

SIZE: A3

SCALE: 1:15

CONSTRUCTION NOTES :

1. TOPS MADE FROM 304 GRADE 1.2mm STAINLESS STEEL.
2. REINFORCING CHANNEL I & II MADE FROM 1.2mm STAINLESS STEEL.
3. SINKS MADE FROM 1.2mm STAINLESS STEEL.
4. FRAME MADE FROM Ø38mm STAINLESS STEEL TUBE.
5. POTRAIL MADE FROM STAINLESS STEEL ROUND TUBE & SQUARE TUBE.
6. FEET ARE ADJUSTABLE STAINLESS STEEL DISC SHAPED FEET.
7. WATERCORP & WATERMARK APPROVED SINK WASTE INCLUDED.

08-7-1800R