

PLAN

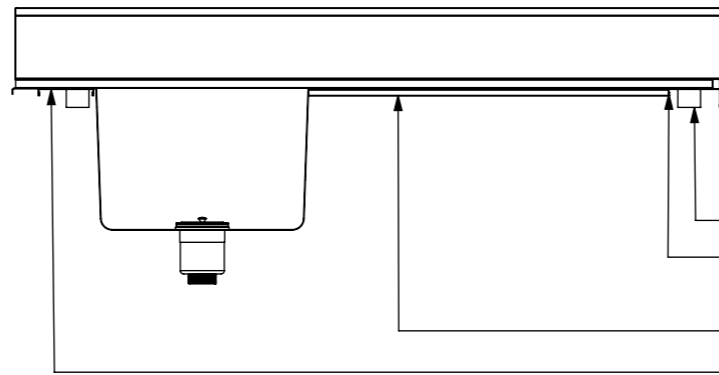

SECTION K-K

SOCKET 38mm x 48mm  
 REINFORCING CHANNEL I  
 TO PUT SOCKET  
 REINFORCING CHANNEL II  
 REINFORCING CHANNEL III  
 TO PUT SOCKET

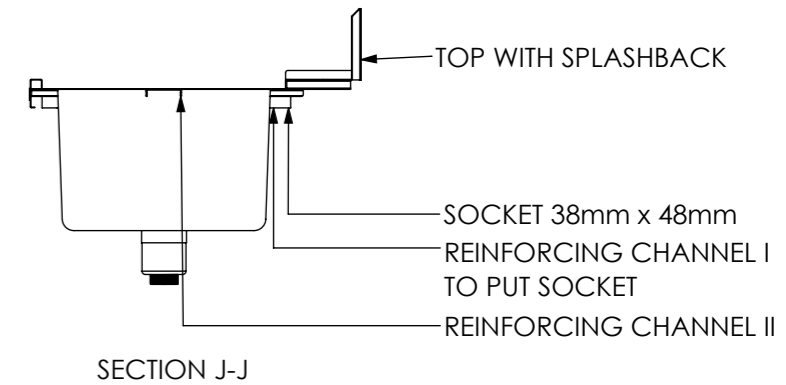

SECTION J-J

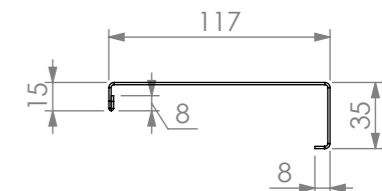

REINFORCING CHANNEL I  
 DETAIL

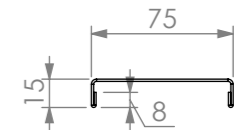

REINFORCING CHANNEL II  
 DETAIL

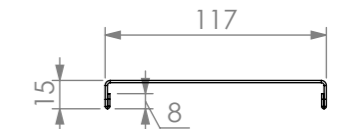

REINFORCING CHANNEL III  
 DETAIL

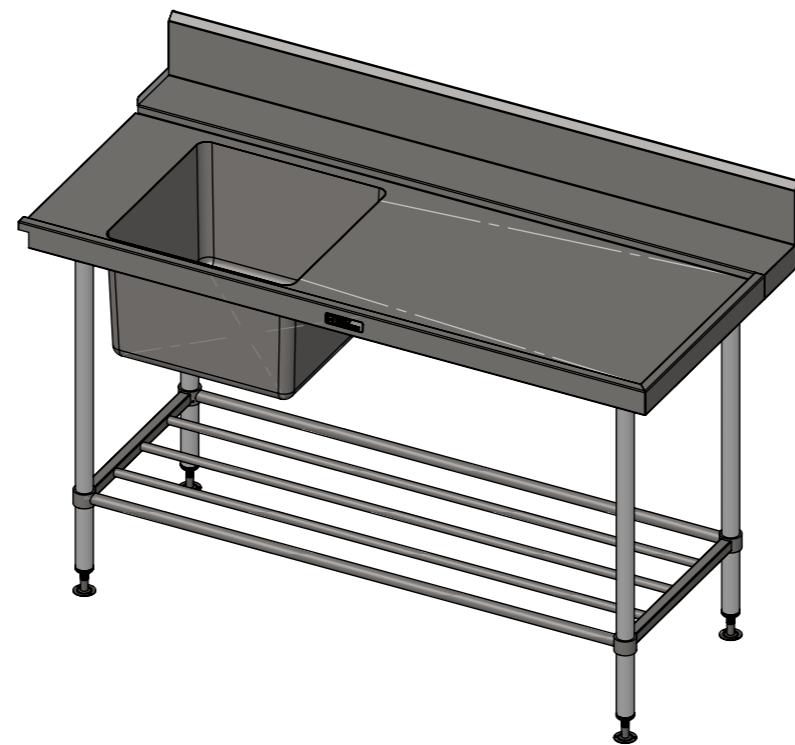

08-7-1500R

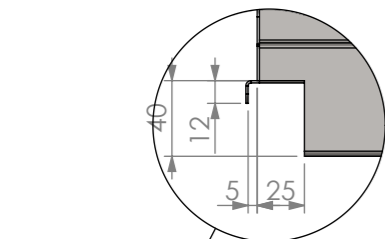

NOTCH DETAIL

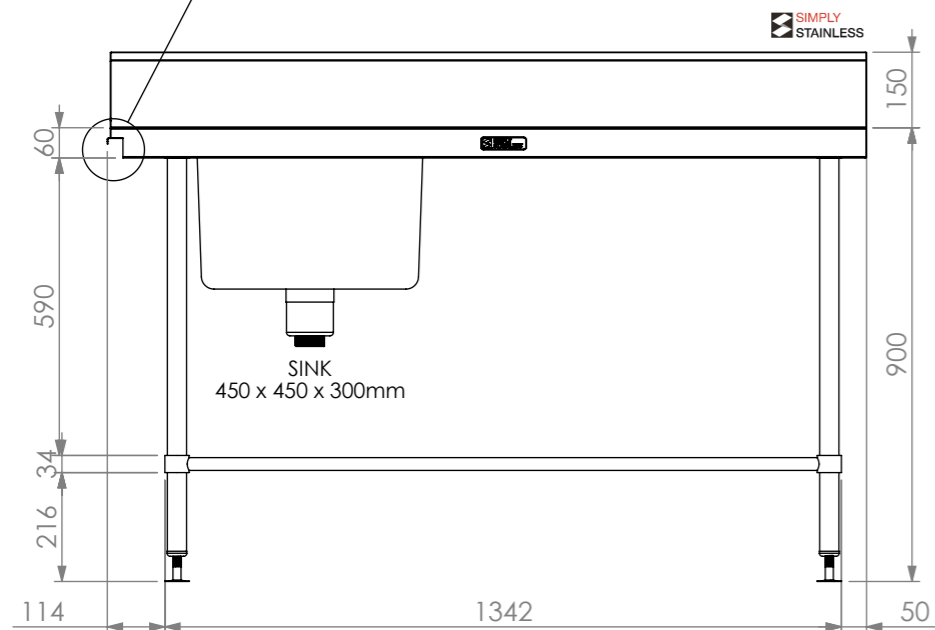

FRONT ELEVATION

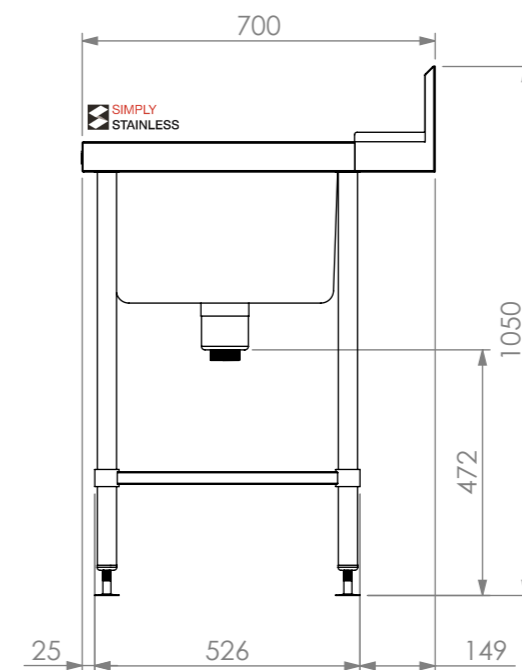

SIDE ELEVATION

**SIMPLY STAINLESS**  
 Modular Sinks, Tables & Shelving  
 COPYRIGHT © 2022  
 This drawing is the property of CI GROUP PTY LTD. Tradings as SIMPLY STAINLESS and It may not be copied, reproduced or modified in whole or in part without prior written permission of CI GROUP PTY LTD. SIMPLY STAINLESS reserves the right to change specification and design without notice.

**08-7-1500R  
 DISHWASH INLET BENCH**

SIZE: A3

SCALE: 1:15

CONSTRUCTION NOTES :

1. TOPS MADE FROM 304 GRADE 1.2mm STAINLESS STEEL.
2. REINFORCING CHANNEL I, II & III MADE FROM 1.2mm STAINLESS STEEL.
3. SINKS MADE FROM 1.2mm STAINLESS STEEL.
4. FRAME MADE FROM Ø38mm STAINLESS STEEL TUBE.
5. POTRAIL MADE FROM STAINLESS STEEL ROUND TUBE & SQUARE TUBE.
6. FEET ARE ADJUSTABLE STAINLESS STEEL DISC SHAPED FEET.
7. WATERCORP & WATERMARK APPROVED SINK WASTE INCLUDED.