

PLAN

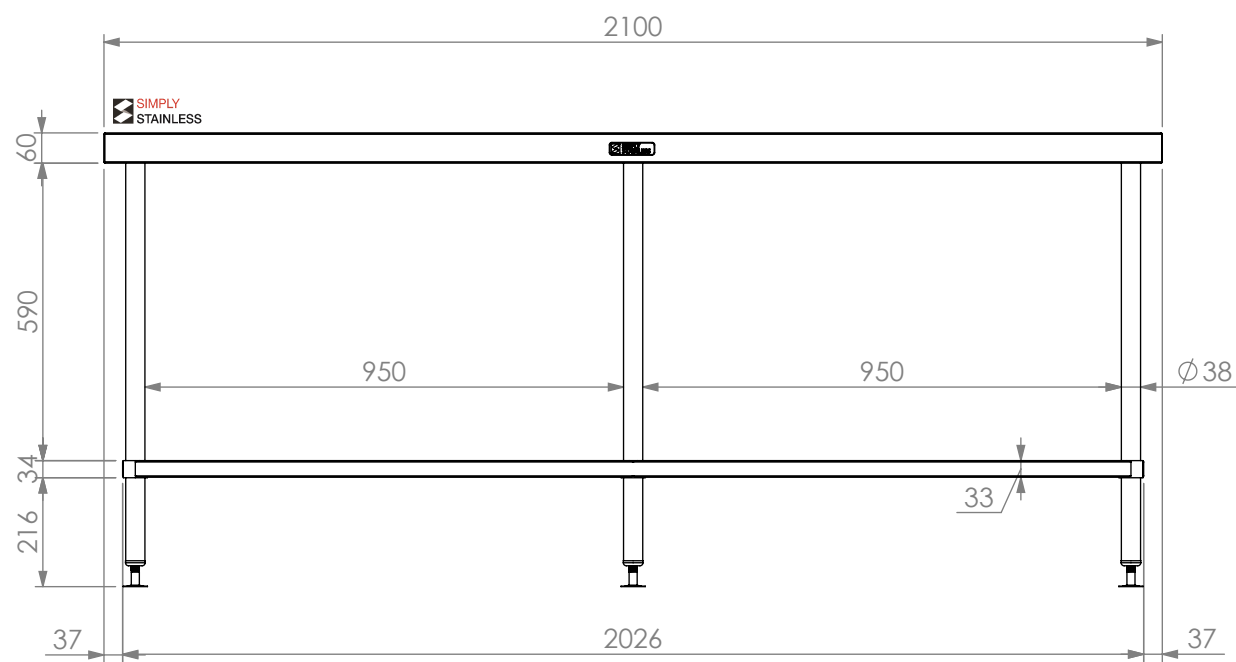

FRONT ELEVATION

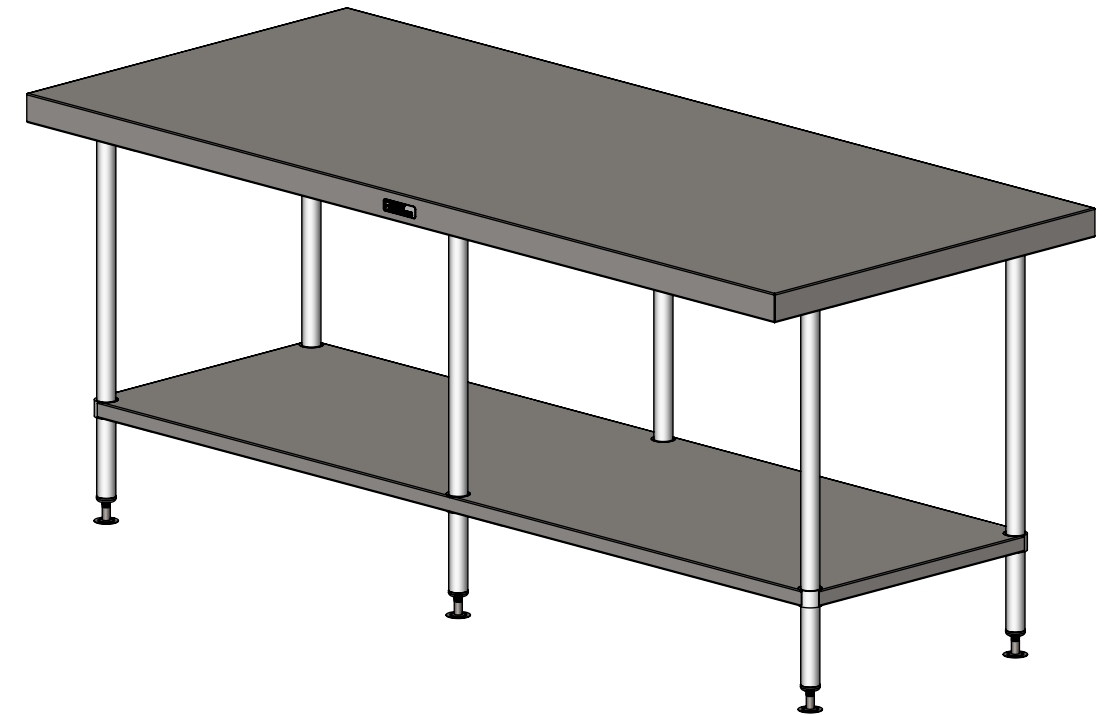
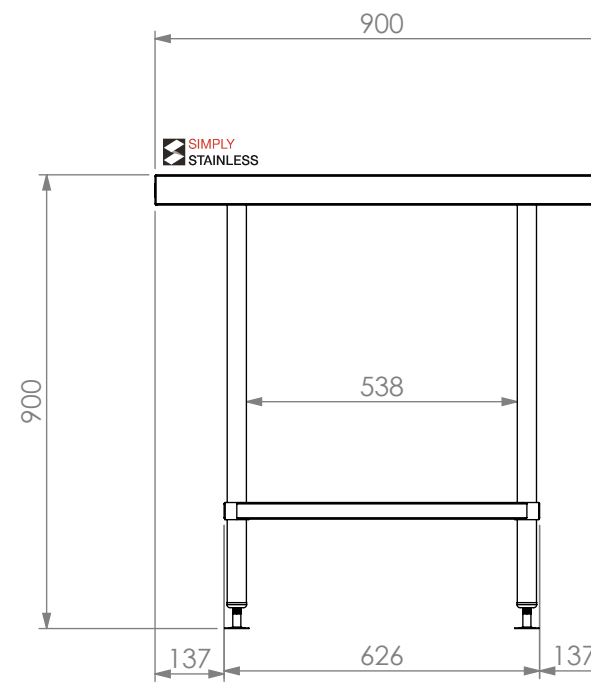

SIDE ELEVATION

01-9-2100

SIMPLY STAINLESS
 Modular Sinks, Tables & Shelving
 COPYRIGHT © 2022
 This drawing is the property of CI GROUP PTY LTD. Tradings as SIMPLY STAINLESS and it may not be copied, reproduced or modified in whole or in part without prior written permission of CI GROUP PTY LTD. SIMPLY STAINLESS reserves the right to change specification and design without notice.

**01-9-2100
 WORK BENCH**

SIZE: A3

SCALE : 1:15

CONSTRUCTION NOTES :

1. TOPS MADE FROM 304 GRADE, 1.2mm STAINLESS STEEL.
2. CORE MADE FROM 3.0mm ZINC ANNEAL.
3. FRAME MADE FROM $\phi 38$ mm STAINLESS STEEL TUBE
4. UNDERSHELF MADE FROM 1.2mm STAINLESS STEEL WITH STAINLESS STEEL SUPPORTS.
5. FEET ARE ADJUSTABLE STAINLESS STEEL DISC SHAPED FEET.